



DATA SHEET

TST



Thermostats



Range from 0 to 50°C ⁽¹⁾, from -20 to +80°C ⁽²⁾ and from -100 to 400°C ⁽³⁾



Visual and audible alarm, red led in front

Features

- RCR relay output 3A/240 Vac (NC), power supply 24 Vac/Vdc
- ABS V0 IP65 housing (remote model) or IP20 (ambient model)
- “1/4 turn” system mounting with wall-mount plate
- Housing with simplified mounting system

Measured parameters

| Parameter | Accuracy ⁽⁴⁾ | Measuring range | Resolution |
|-------------|---|--|------------|
| Temperature | Pt100: ±0.5% of reading ±0.5°C NTC: ±0.3°C (from -40°C to 70°C); ±0.5°C beyond | Ambient model: from 0 to 50°C Duct model: from -20 to +80°C Model with terminal block: from -100 to +400°C | 0.1°C |

Part number

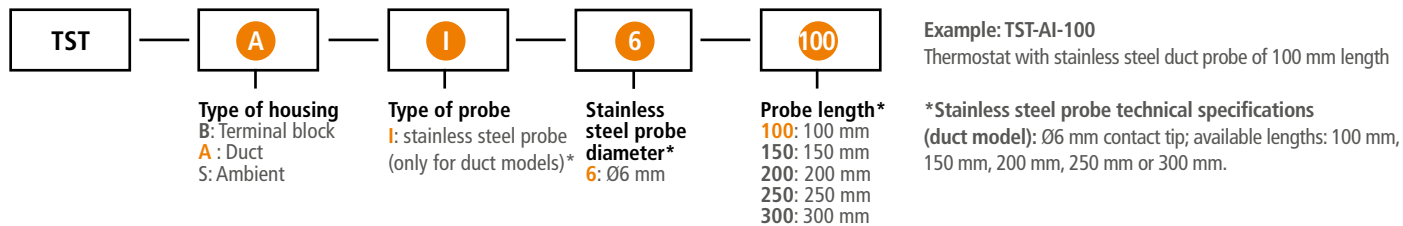

Technical specifications

| | |
|------------------------|--|
| Output | 1 RCR relay 3 A / 230 Vac. NO (normally opened): 5A / NC (normally closed): 3A / 240 Vac. Common mode voltage <30 Vac. |
| Power supply | 24 Vac/Vdc ±10% |
| Consumption | 3 VA |
| Relay and alarm status | Red led in front and internal buzzer (70 dB at 10 cm) |
| European directives | 2014/30/EU EMC; 2014/35/EU Low Voltage; 2011/65/EU RoHS II; 2012/19/EU WEEE |
| Electrical connection | Terminal block for cables Ø0.05 to 2.5 mm ² . Carried out according to the code of good practice |
| PC communication | USB-mini Din cable |
| Environment | Air and neutral gases |

⁽¹⁾ Ambient model / ⁽²⁾ Duct model / ⁽³⁾ Pt100 terminal block model

⁽⁴⁾ All the accuracies indicated in this technical datasheet were stated in laboratory conditions, and can be guaranteed for measurements carried out in the same conditions, or carried out with calibration compensation.

General features

| | |
|------------------------------|--|
| Units of measurement | °C, °F |
| Response time | 1/e (63%) 5 sec. (ambient) 1/e (63%) 20 sec. (airtight) |
| Type of sensor | Pt100 (model with terminal block and stainless steel duct model) NTC (ambient model and duct model) |
| Type of fluid | Air and neutral gas |
| Conditions of use (°C/%RH/m) | From 0 to +50°C. In non-condensing condition. From 0 to 2000 m. |
| Storage temperature | From -10 to +70°C |

Features of the housing

| | |
|--|--|
| Material | ABS V0 as per UL94 |
| Protection | Duct model and model with terminal block: IP65 Ambient model: IP20 |
| Display | LCD 10 digits. Size: 50 x 17 mm Height of digits: Values: 10 mm; Units: 5 mm |
| Weight | 162 g |
| Cable gland (duct and terminal block models) | For cables of Ø8 mm maximum |
| Cable of remote probe | 2 m length, Ø4.8 mm in PVC |

Dimensions

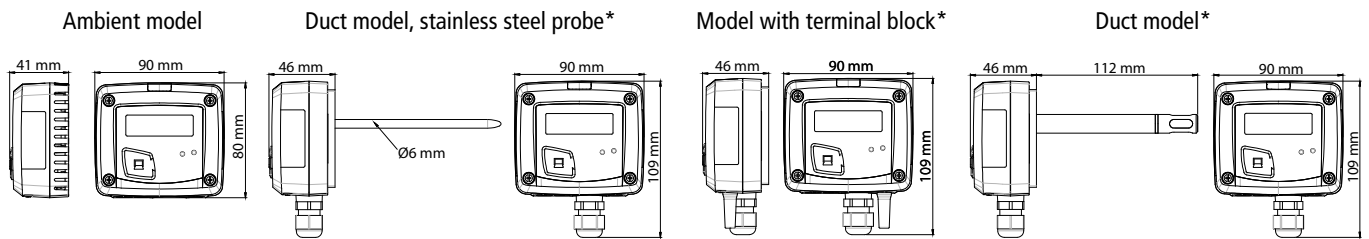

Connections

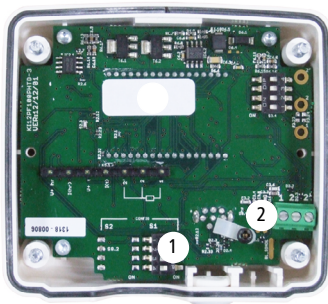

Inside the front housing



Removable front face

Fixed back housing

Connection of a Pt100 probe on terminal block:

Measuring probe

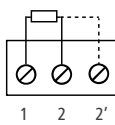

- | | |
|---|--------------------------------|
| 1. Switch | 5. Button for settings |
| 2. Terminal block (only on model with terminal block) | 6. Relay terminal block |
| 3. LCC-S software connection | 7. Power supply terminal block |
| 4. Alarm led | 8. Cable gland |

Symbols used

For your safety and in order to avoid any damage of the device, please follow the procedure described in this document and read carefully the notes preceded by the following symbol:



The following symbol will also be used in this document, please read carefully the information notes indicated after this symbol:



Electrical connections as per NFC15-100 standard



This connection must be performed by a qualified and trained technician. To make the connection, the transmitter must not be energized.

NO: normally opened
COM: common
NC: normally closed

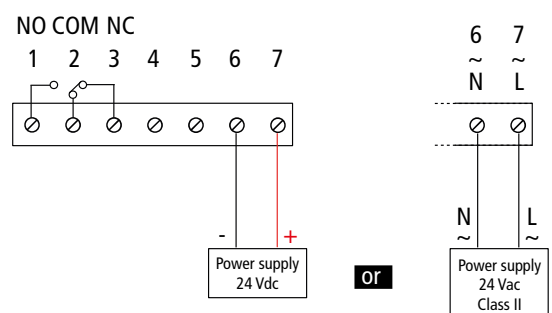

*Different probes available as option. Stainless steel probe technical specifications (duct model): Ø6 mm contact tip; available lengths: 100 mm, 150 mm, 200 mm, 250 mm or 300 mm.

Settings and use of the transmitter

• Configuration



CAUTION: to configure the transmitter, it must not be energized. Then, you can make the settings required, with the DIP switches (as shown on the drawing below). When the transmitter is configured, you can power it up.

To configure the transmitter, unscrew the 4 screws of the casing then open it. The switches allowing the different settings are accessible.

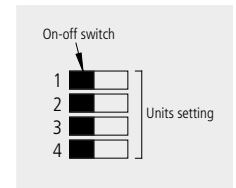









• Units setting

To set a unit of measurement, put the on-off switch 4 of the units as shown beside.

• Thresholds configuration

The button  allows to activate or not an alarm (threshold), to set the action of the alarm (edge), to set the threshold(s) value, to set the time-delay and to acknowledge the alarm.

| Configurations | ° C | ° F |
|----------------|---|---|
| Combinations | 1  | 1  |
| | 2  | 2  |
| | 3  | 3  |
| | 4  | 4  |

Working principle:

- By pressing the button more than 3 seconds, you can validate the setting and go to the next setting.
- By pressing quickly the button, you can increment a value and scroll down the different option or values.

• Activate or deactivate an alarm

- Press the button for 3 seconds, "CONF" is displayed then "NEG", meaning that the relay is in negative security, it is excited during an alarm condition.
- If needed, press quickly the button to switch the relay in positive security, the relay is de-energized during an alarm condition or a current breaking, "POS" is displayed.
- Press 3 seconds the button, "Buzz" screen is displayed with "ON" or "OFF" blinking. Briefly press on the button to activate ("ON") or deactivate ("OFF") (according to the last saved configuration) the buzzer during an alarm condition.
- Press the button for 3 seconds, "Alarm" screen is displayed with "On" or "Off" blinking (according to the last saved configuration).
- Press quickly the button, the display changes from "On" (activated alarm) to "Off" (deactivated alarm).
- Press the button for 3 seconds to confirm the setting. If the alarm is deactivated, the instrument displays the measurement; if the alarm is activated, the instrument displays the following setting.

• Set the action of the alarm (rising edge or falling edge)

The edge determines the action of the alarm according to the trespassing direction of the threshold(s).

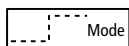

Rising edge (1 threshold): the alarm goes off when the measurement exceeds the threshold and stops when it is below the threshold.

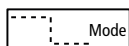

Falling edge (1 threshold): the alarm goes off when the measurement is below the threshold and stops when it exceeds the threshold.

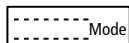

Monitoring (2 thresholds): the alarm goes off when the measurement is outside the defined low and high thresholds.

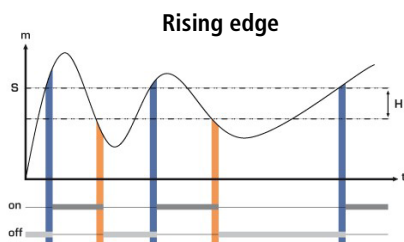

Measurement (m) > Threshold (S) during the time-delay T1: alarm activation.
Measurement (m) < Threshold (S) - Hysteresis (H) during the time-delay T2: alarm deactivation.

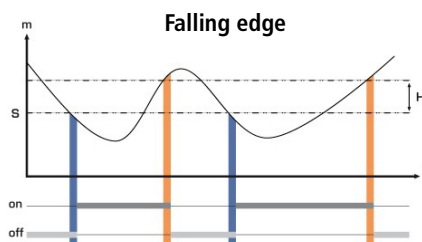

Measurement (m) < Threshold (S) during the time-delay T1: alarm activation.
Measurement (m) > Threshold (S) + Hysteresis (H) during time-delay T2: alarm deactivation.

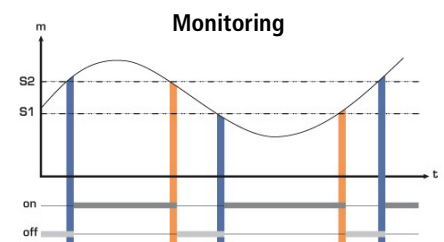

The alarm goes off when the measurement is outside the low and high thresholds.

- Press briefly the button to select the trespassing direction then press the button more than 3 seconds to validate this direction and set the thresholds.

• Set the threshold(s) value

The first digit blinks, it corresponds to the positive (0) or negative (-) setting of the threshold value. Press briefly the button to select the sign for the threshold value. Press the button more than 3 seconds to validate.

The second digit blinks, press briefly the button to scroll the numbers. Press the button more than 3 seconds to validate.

Repeat the process until the last digit to configure the threshold value, validate the threshold and go to the following setting.

If the monitoring edge has been selected, the transmitter displays the setting of the second threshold.

- **Set the hysteresis**

The hysteresis only concerns the rising edge and the falling edge modes.

In rising edge mode, the hysteresis allows to the transmitter to stay in alarm when the measurement is between the threshold and the threshold minus the hysteresis.

Example: for a 70°C threshold and a 10°C hysteresis, the instrument will stay in alarm when the measurement will be between 70 and 60°C.

In falling edge mode, the hysteresis allows to the transmitter to stay in alarm when the measurement is between the threshold and the threshold plus the hysteresis.

Example: for a 70°C threshold and a 10°C hysteresis, the instrument will stay in alarm when the measurement will be between 70 and 80°C. The first digit blinks, set it by pressing the button briefly several times then press on the button more than 3 seconds to set the following digit.

Once the hysteresis is set, press the button more than 3 seconds to validate and set the time-delays.

- **Set the time-delay 1 and the time-delay 2 (600 seconds maximum)**

- In rising edge mode, the time-delay 1 corresponds to the time lag before the alarm goes off when the threshold has been reached. The time-delay 2 corresponds to the time lag before the alarm stops when the measurement is lower than the threshold minus the hysteresis.

Setting procedure: "Time 1" for the time-delay 1 is displayed then the time in second. The first digit blinks, press briefly on the button and scroll the figures. Press on the button more than 3 seconds to validate. Repeat the process until the last digit to set the time-delay 1 value (from 0 to 600 s) and validate. **"Time 2"** is displayed the time in second. Repeat the process to set the time-delay 2.

- In falling edge mode, the time-delay 1 corresponds to the time lag before the alarm goes off when the threshold has been reached. The time-delay 2, corresponds to the time lag before the alarm stops when the measurement is lower than the threshold plus the hysteresis. The setting procedure is the same as the rising edge procedure.

- In monitoring mode, the alarm of the transmitter goes off when the measurement is below the lower threshold and higher the high threshold. The time-delay 1 corresponds to the time lag before the alarm goes off when the measurement is below the lower threshold and higher the high threshold. The time-delay 2 corresponds to the time lag before the alarm stops when the measurement is between the lower and higher thresholds.

The setting procedure is the same as the rising edge procedure.

The setting of time delays is done, the measurement is displayed.

Configuration via LCC-S software (optional)

The software allows to set the alarms, the thresholds, and the time-delay of the transmitter.

- To access the configuration via software:
 - Set the DIP switches as shown beside.
 - Connect the cable of the LCC-S to the connection of the transmitter. Please refer to the user manual of the LCC-S software to make the configuration.
- Please refer to the user manual of the LCC-S software to make the configuration.

! The configuration of the parameters can be done either with the DIP switch or the software (combining both solutions is not possible). **SWITCH OFF THE SENSOR before settings process.**



Active switch

Mounting

To mount the transmitter, mount the ABS plate on the wall (drilling: Ø6 mm, screws and pins are supplied). Insert the transmitter on the fixing plate (see A on the drawing beside). Rotate the housing in clockwise direction until you hear a "click" which confirms that the transmitter is correctly installed.

! No fixing plate is available for ambient model. 4 fixing holes are inside the back housing. Use them to install the transmitter on the required location.

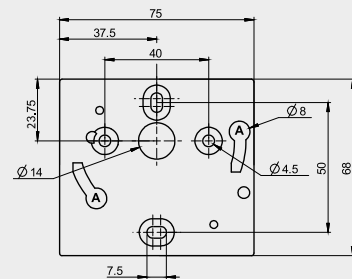

Maintenance: please avoid any aggressive solvent. Please protect the transmitter and its probes from any cleaning product containing formalin, that may be used for cleaning rooms or ducts.

Precautions for use: please always use the device in accordance with its intended use and within parameters described in the technical features in order not to compromise the protection ensured by the device.

Accessories

| Name | Reference |
|--|-----------|
| Power supply class 2, 230 Vac input, 24 Vac output | KIAL-100A |
| Configuration software with USB cable | LCC-S |
| Stainless steel Pt100 2 or 3 wires probes or NTC probes for duct models and remote models available on request | - |



Only the accessories supplied with the device must be used.

